

# LISTWY I GZYMSY POWLEKANE

(długość 1200 mm)

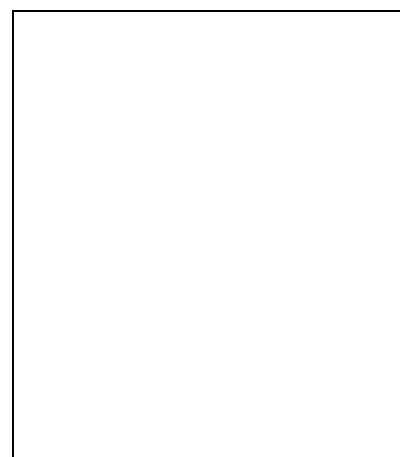
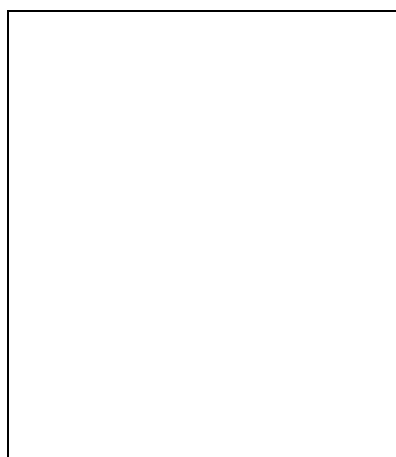
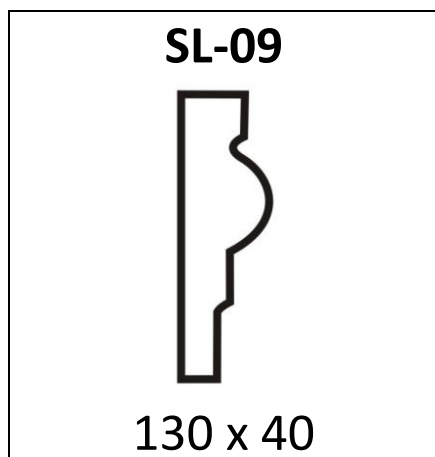
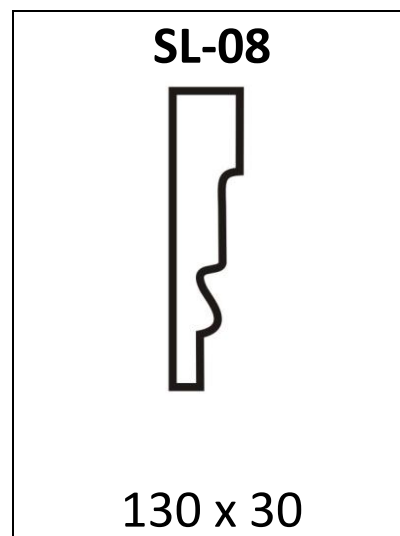
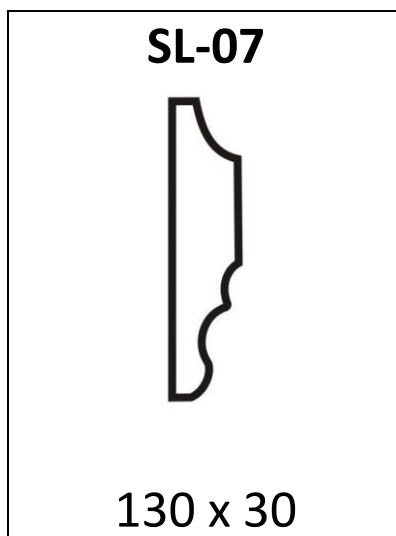
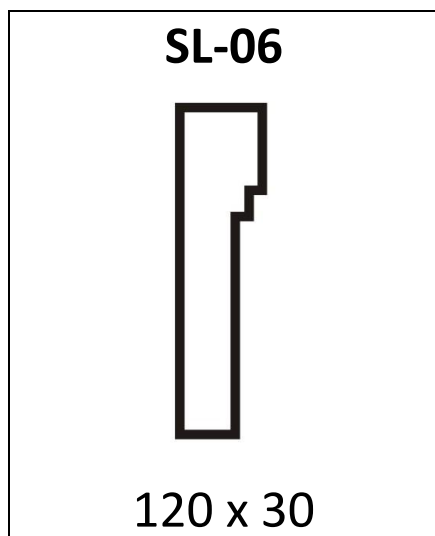
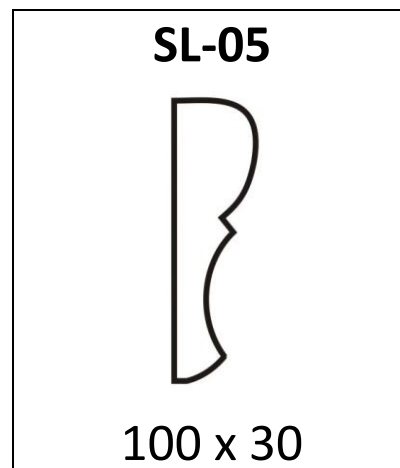
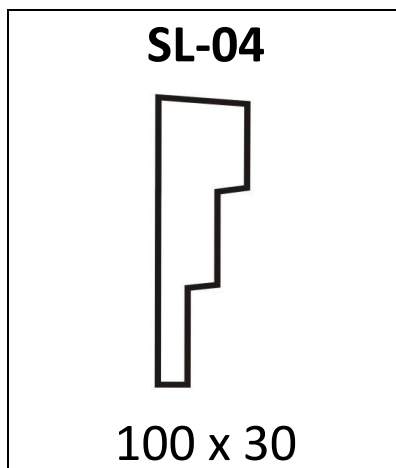
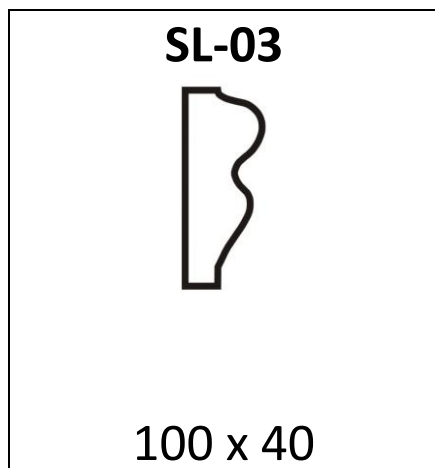

# LISTWY I GZYMSY POWLEKANE

(długość 1200 mm)

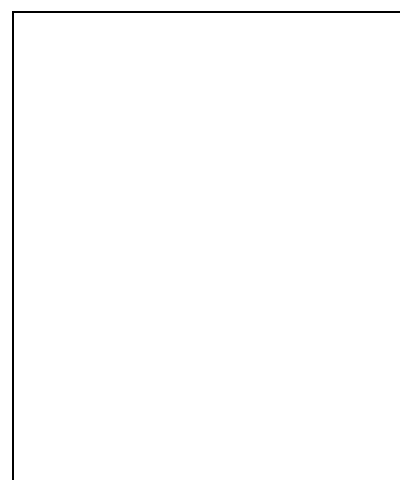
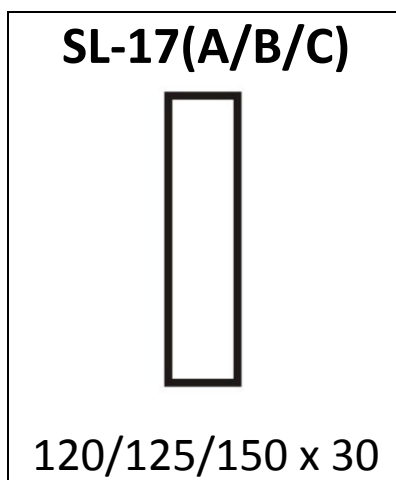
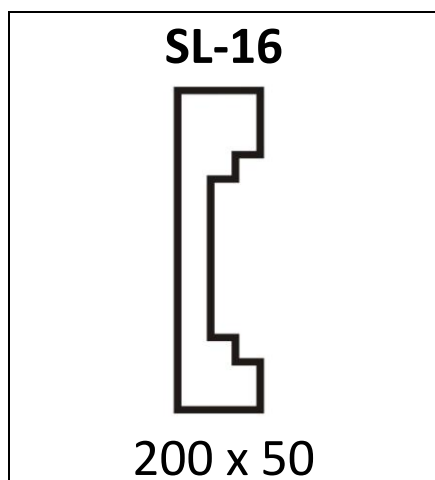
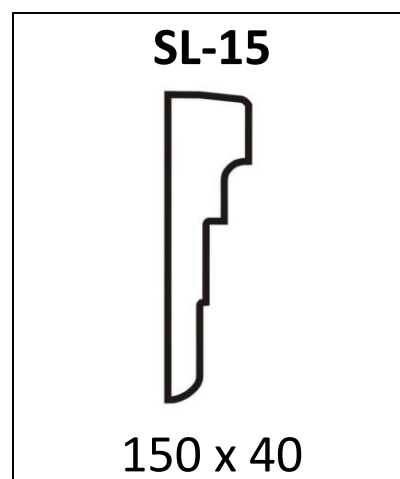
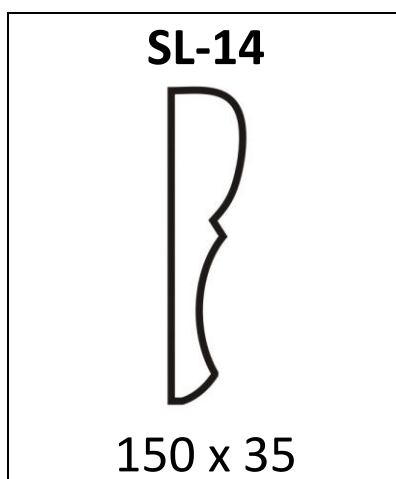
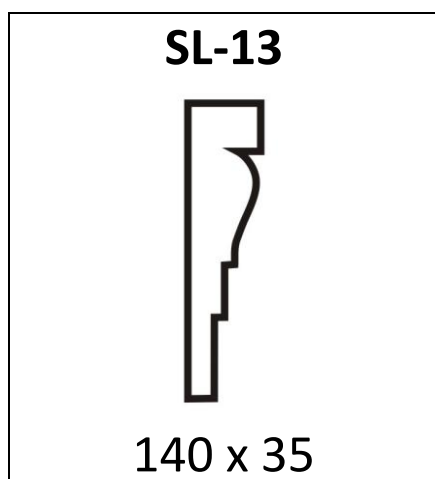
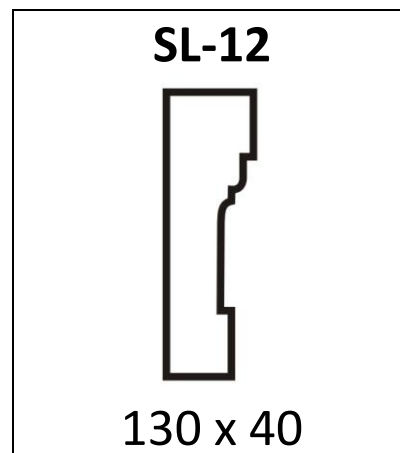
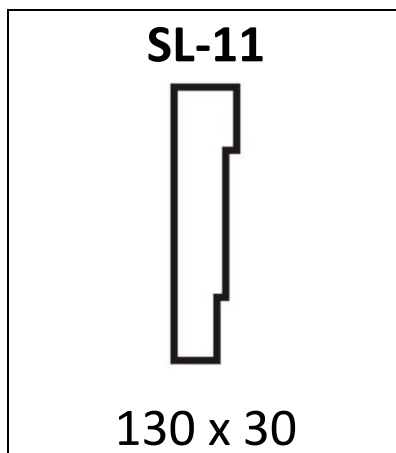
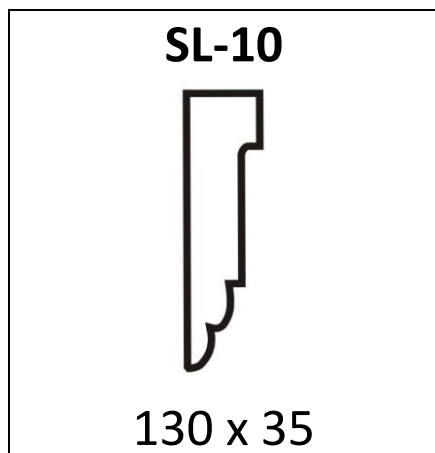

# LISTWY I GZYMSY POWLEKANE

(długość 1200 mm)

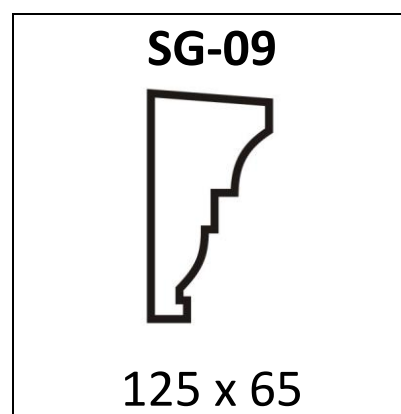
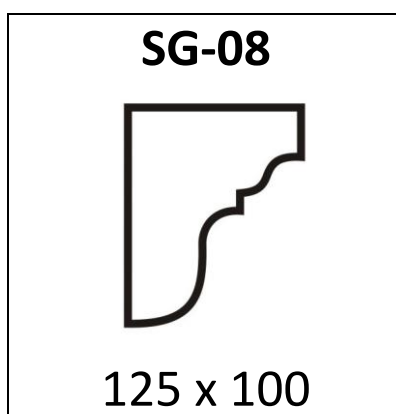
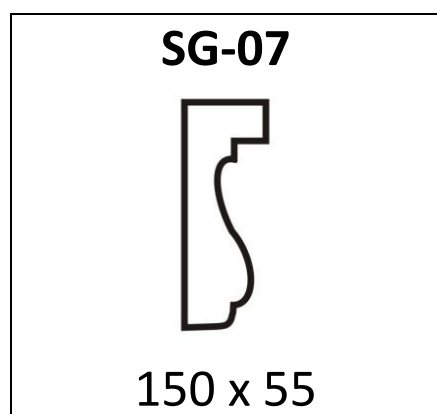
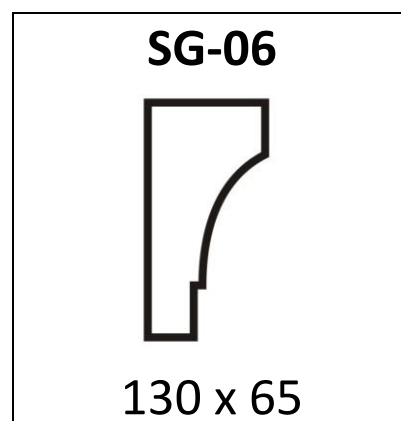
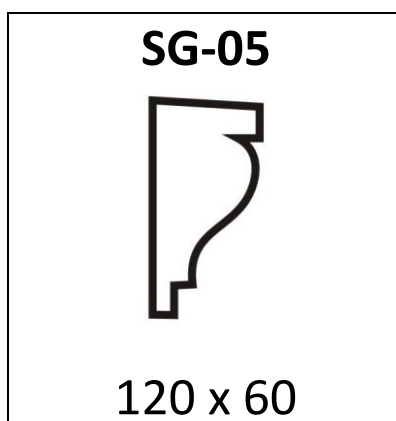
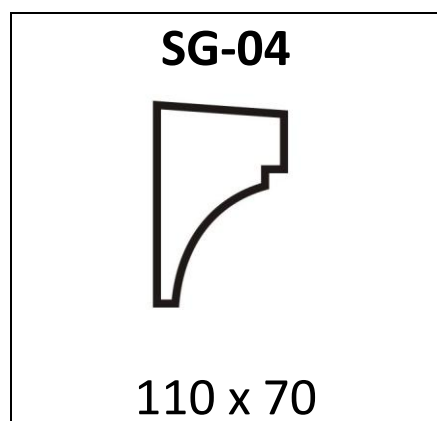
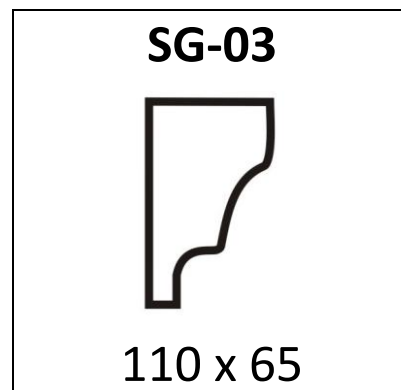
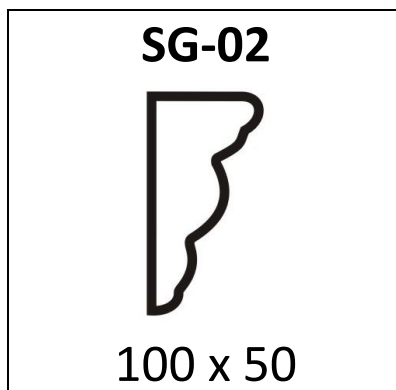
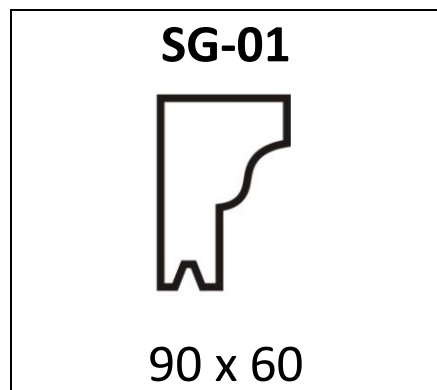

# LISTWY I GZYMSY POWLEKANE

(długość 1200 mm)

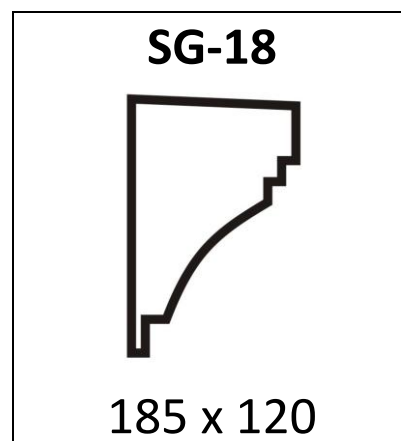
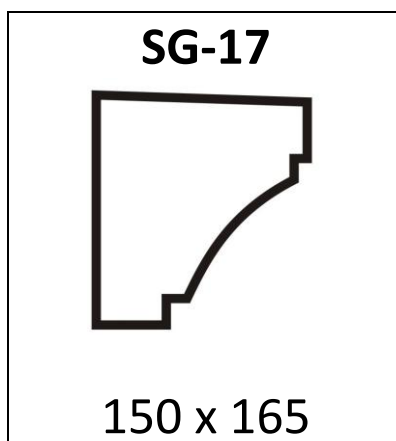
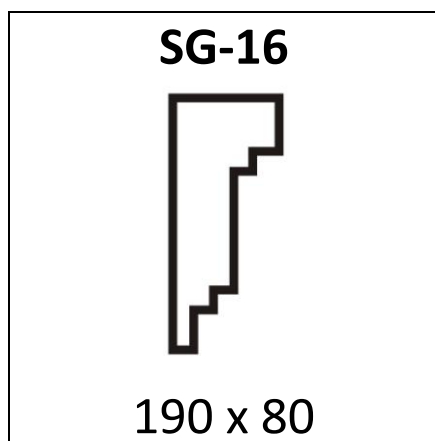
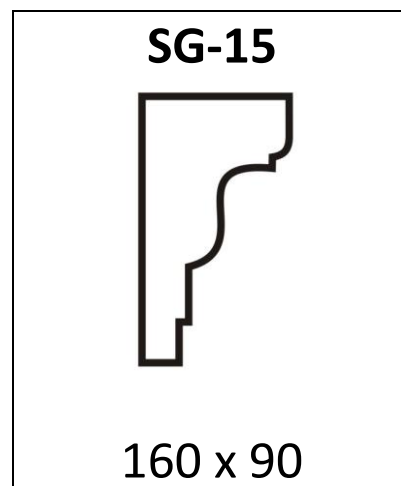
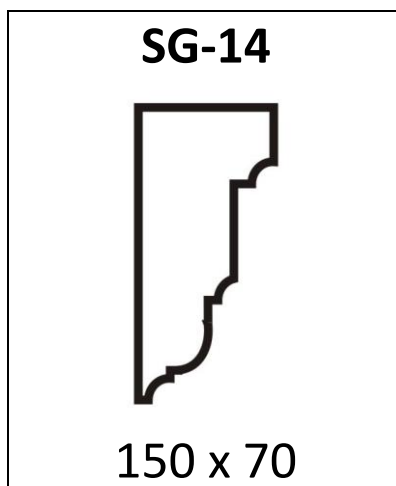
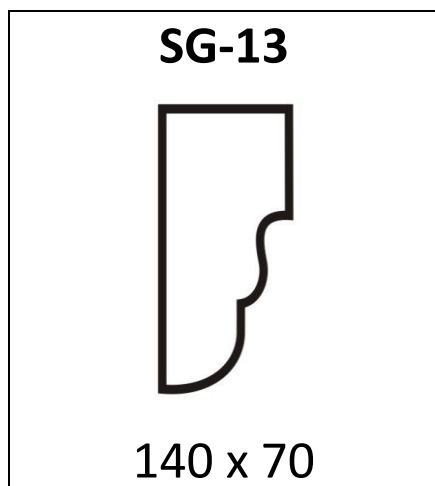
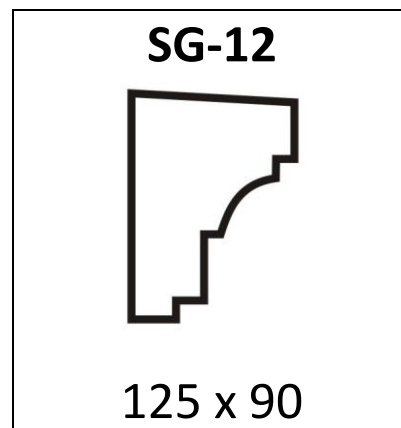
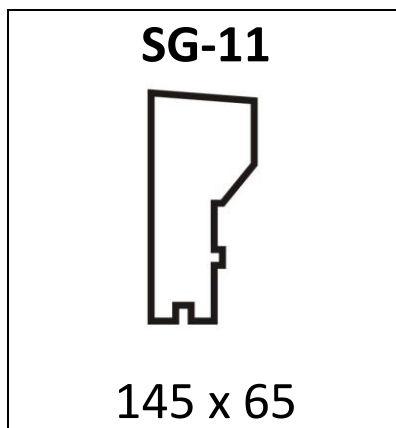
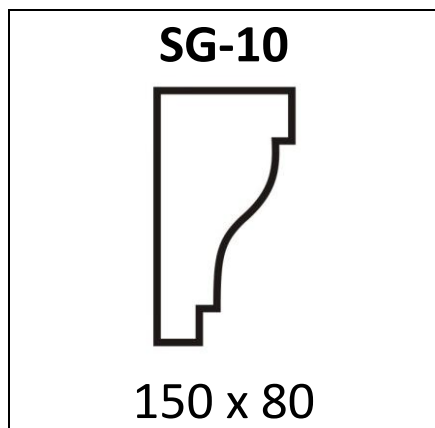

# LISTWY I GZYMSY POWLEKANE

(długość 1200 mm)

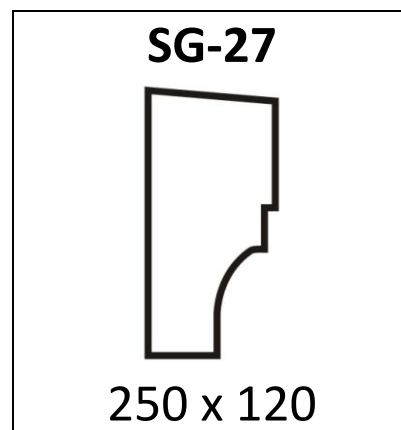
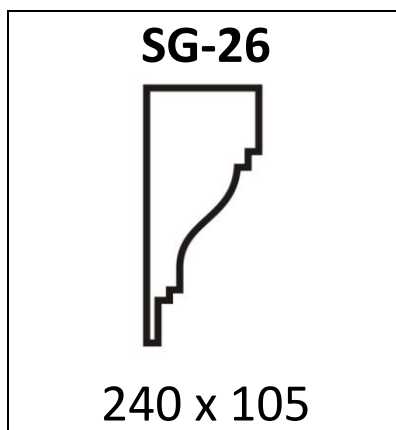
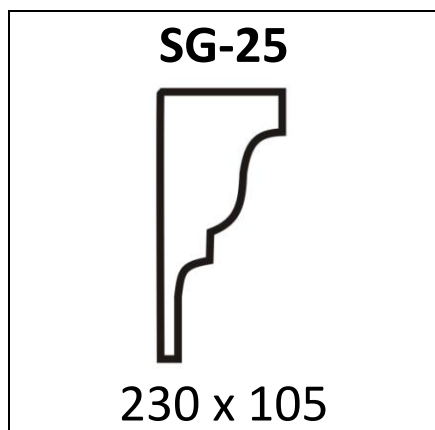
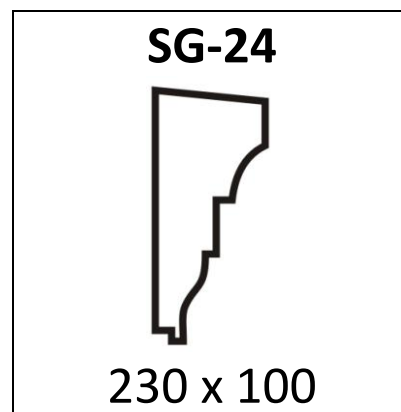
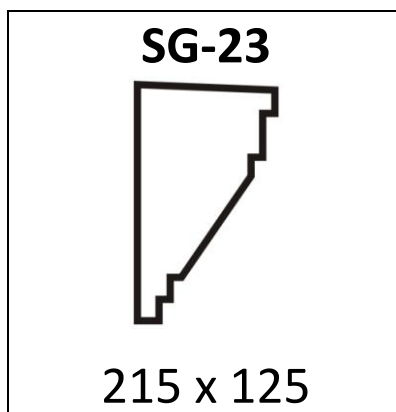
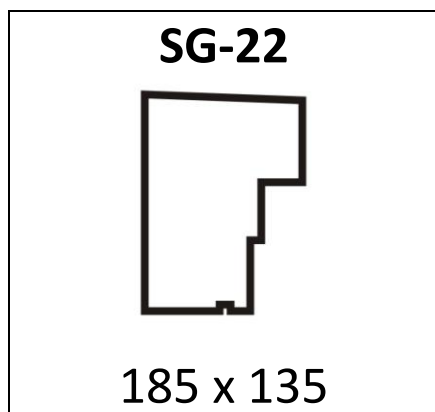
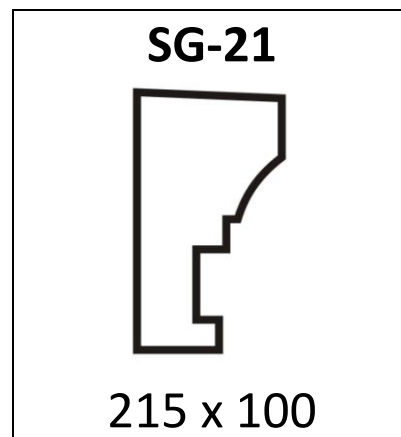
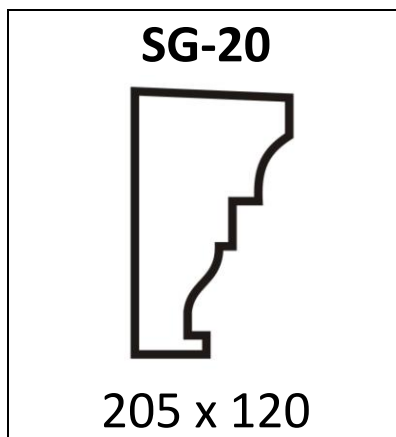
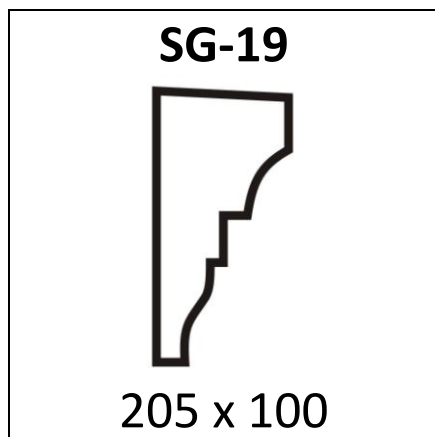

# LISTWY I GZYMSY POWLEKANE (długość 1200 mm)

